



Typical Features

- ◆ Wide input voltage range 4:1
- ◆ Efficiency up to 90%
- ◆ Low no-load power consumption
- ◆ Operating Temperature from -40°C to +105°C
- ◆ High isolation voltage 2100VDC(input-output) & 2100VDC(input-case)
- ◆ Input under voltage protection, output over voltage, short circuit, over current and over temp protections
- ◆ Standard 1/4 brick size

Conform to CE

ZCD150-24S24A is a high-reliability DC-DC converter with the rated input voltage 24VDC (full range from 9V to 36VDC), regulated single output 24V/150W without minimum load limit. It has the advantages of high isolation voltage, operating temperature(metal base) 105°C Max, with the input under-voltage protection, output over-current, over-voltage, over-temperature and short circuit protections, input remote control, output voltage distal end compensation and output Trim functions, etc.

Typical Product List

Part No.	Input voltage range (VDC)	Output power (W)	Output voltage (VDC)	Output current (A)	Ripple & Noise (mVp-p)	Full load efficiency (%) Min/Typ.	Remarks
ZCD150-24S24AC	9 - 36	150	24	6.25	240	88/90	Standard Positive logic
ZCD150-24S24AN							Standard Negative logic
ZCD150-24S24AC-H							Heatsink Positive logic
ZCD150-24S24AN-H							Heatsink Negative logic

Note - The output power could be derated linearly at the input voltage range of 9-18V, the Max output power can be 100W at input voltage 9V.

Input Specifications

Item	Operating conditions	Min.	Typ.	Max.	Unit
Max input current	Input voltage 9V, output 100W	--	--	14	A
No load input current	Rated input voltage	--	--	30	mA
Input Inrush voltage (1sec. max.)	The unit could be permanently damaged by input over this Voltage	-0.7	--	50	VDC
Start-up voltage		--	--	10	
Input under voltage protection	With No-load (over current protection will start in advance at full load)	--	--	9	
Remote Control (CNT)	Positive logic - CNT no connection or connect to 3.5-15V to turn on, connect to 0-1.2V to shut off the converter				Reference voltage -Vin
	Negative logic - CNT no connection or connect to 3.5-15V to shut off, connect to 0-1.2V to turn on the converter				

Output Specifications

Item	Operating conditions	Min.	Typ.	Max.	Unit
Output Voltage Accuracy	Rated input voltage, 0% -100% load	--	±0.2	±1.0	%
Line Regulation	Full load, input voltage from low to high	--	±0.2	±0.5	
Load Regulation	Rated input voltage, 10%-100% load	--	±0.2	±0.5	
Transient recovery time	25% load step change (step rate 1A/50uS)	--	200	250	uS
Transient Response Deviation		-5	--	+5	%
Temperature Drift Coefficient	Full load	-0.02	--	+0.02	%/°C
Ripple & Noise	20M bandwidth, test with capacitor above 220uF	--	150	240	mVp-p
Output voltage adjustment (TRIM)		-20	--	+10	%
Output voltage distal end compensation (Sense)		--	--	105	%
Over temperature protection	Maximum temperature of the metal base	105	115	125	°C
Over voltage protection		125	--	140	%
Over current protection		6.5	--	9	A
Short circuit protection		Hiccup, continuous, self-recovery			

General Specifications

Item	Operating conditions		Min.	Typ.	Max.	Unit
Isolation Voltage	I/P-O/P	Test 1min, leakage current < 3mA	--	--	2100	VDC
	I/P-Case	Test 1min, leakage current < 3mA	--	--	2100	VDC
	O/P-Case	Test 1min, leakage current < 3mA	--	--	500	VDC
Insulation resistance	I/P-O/P	@ 500VDC	100	--	--	MΩ
Switching frequency			--	330	--	KHz
MTBF			150	--	--	K hours

Environmental characteristics

Item	Operating conditions	Min.	Typ.	Max.	Unit
Operating Temperature	Refer to the temperature derating curve	-40	--	+105	°C
Storage Humidity	No condensing	5	--	95	%RH
Storage Temperature		-40	--	+125	°C
Pin Soldering temperature	1.5mm from the case, soldering time < 1.5S	--	--	+350	
Cooling requirements		EN60068-2-1			
Dry heat requirement		EN60068-2-2			
Damp heat requirement		EN60068-2-30			
Shock and vibration		IEC/EN 61373 C1/Body Mounted Class B			

EMC Performances (EN50155)

EMI	CE	EN50121-3-2	150kHz-500kHz 79dBuV	
		EN55016-2-1	500kHz-30MHz 73dBuV	
	RE	EN50121-3-2	30MHz-230MHz 40dBuV/m at 10m	
		EN55016-2-1	230MHz-1GHz 47dBuV/m at 10m	
EMS	ESD	EN50121-3-2	Contact ±6KV / Air ±8KV	perf. Criteria A
	RS	EN50121-3-2	10V/m	perf. Criteria A
	EFT	EN50121-3-2	±2kV 5/50ns 5kHz	perf. Criteria A
	Surge	EN50121-3-2	Line to line ± 1KV (42Ω, 0.5μF)	perf. Criteria A
	CS	EN50121-3-2	0.15MHz-80MHz 10 Vr.m.s	perf. Criteria A

Physical Characteristics

Case Materials	Metal bottom shell + plastic case in black, flame class UL94 V-0
Heat sink	Dimension 61.0x39.0x15.0 mm, weight 52g, aluminum alloy, anodized black
Cooling method	Conduction cooling or forced air cooling with fan
Product Weight	Standard 72g, with heatsink 125g

Mechanical Dimensions and Pin-Out description

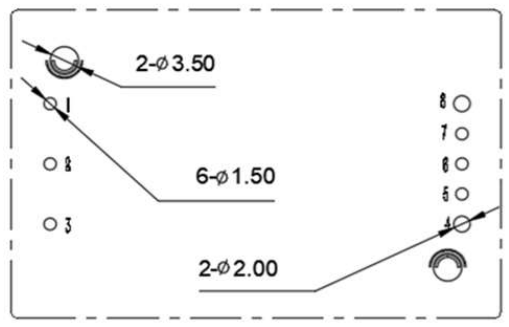
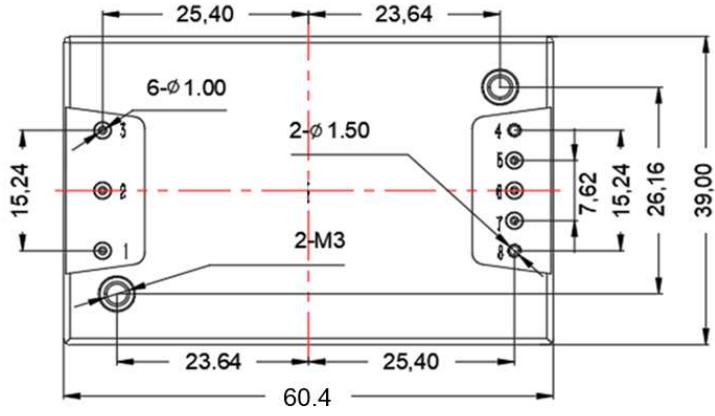

Recommended PCB holes size

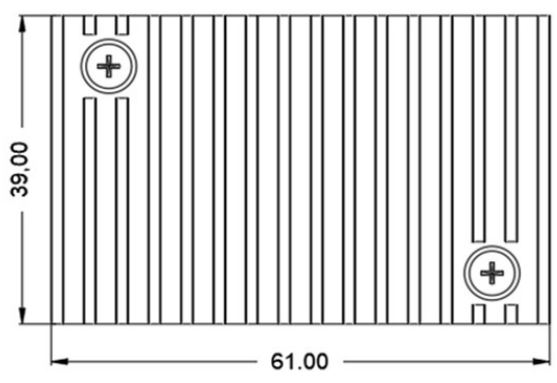
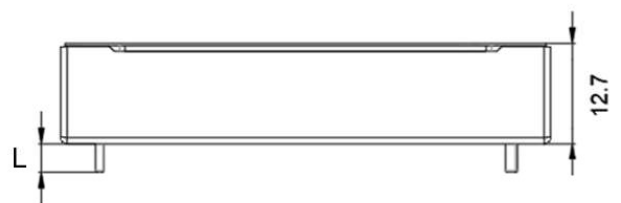
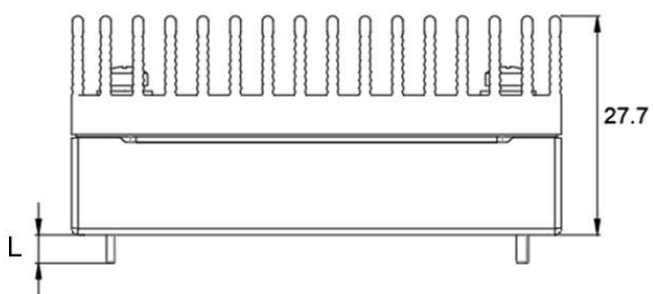

Standard+Heatsink
61.0x39.0x27.7mm

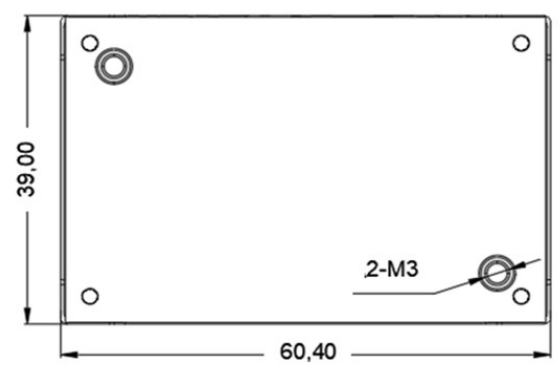

Standard
60.4x39.0x12.7mm

Note:
Unit: mm
Pin 1,2,3,5,6,7 diameter: 1.00
Pin 4,8 diameter: 1.50
Tolerance: X.X ±0.50mm, X.XX ±0.10mm
Screwing torque: 0.4N.m Max

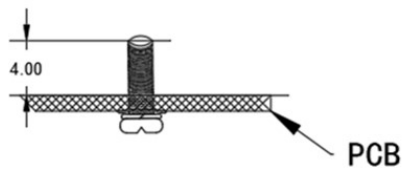

Pin length L=3.7mm

No.	1	2	3	4	5	6	7	8
Pin-out	Vin+	CNT	Vin-	Vout-	-Sense	TRIM	+Sense	Vout+
Description	Input V+	Remote Control	Input V-	Output V-	Output distal end compensation S-	Output Voltage Trim	Output distal end compensation S+	Output V+

Product Performance Curves

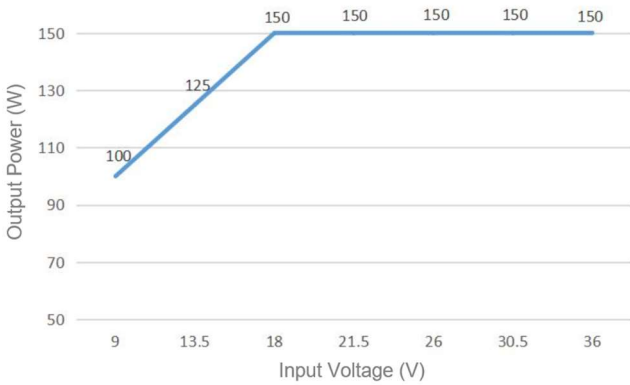
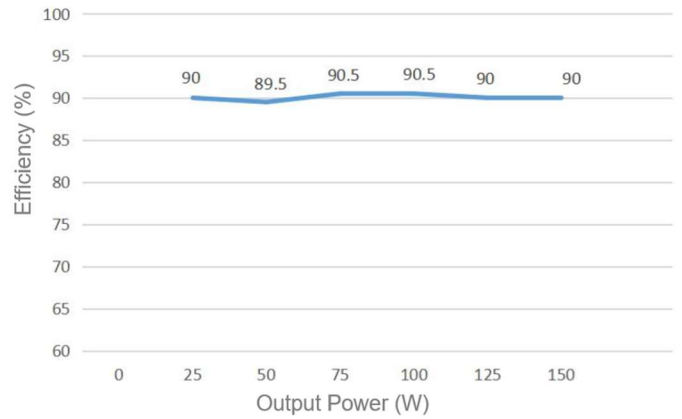
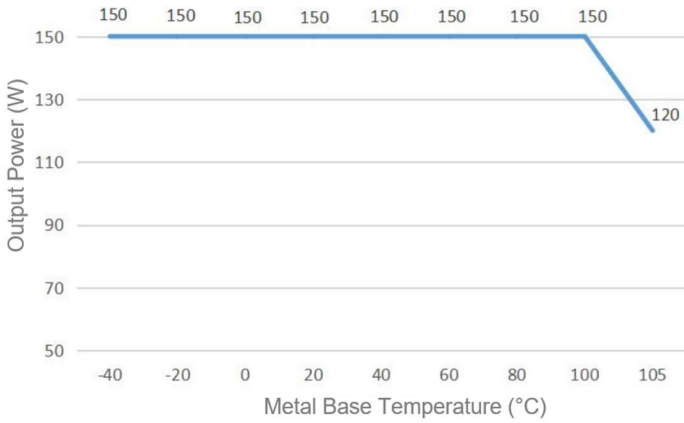

Note:

1. The output power and the efficiency in the curves are tested with typical values.
2. The data in temperature derating curve is tested at Aipu laboratory test conditions. It is recommended to keep the temperature of the Metal base not more than 100 °C while the converter operates at the rated load for the customer application.

Recommended circuits for application

1. Ripple and Noise

All this series of converters will be tested according to the circuit below before shipping.

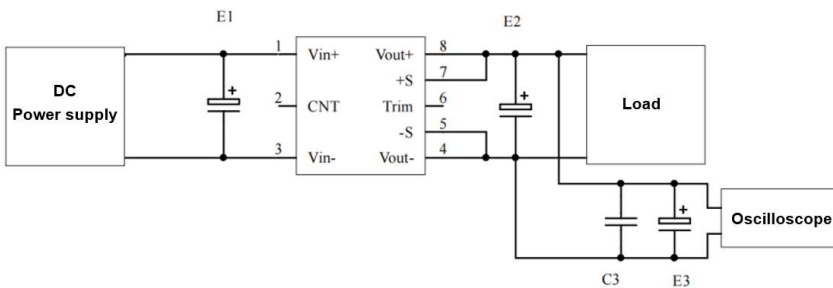

Capacitance	E1 (μF)	E2 (μF)	C1 (μF)	E3 (μF)
Output Volt. 3.3VDC	100	1000	1	10
5VDC		680		
12VDC		220		
.....	68	68		
48VDC				
110VDC				

2. Typical application circuit

If this circuit recommended below is not adopted, please connect an electrolytic capacitor $\geq 100 \mu\text{F}$ in parallel at the input to suppress the possible surge voltage.

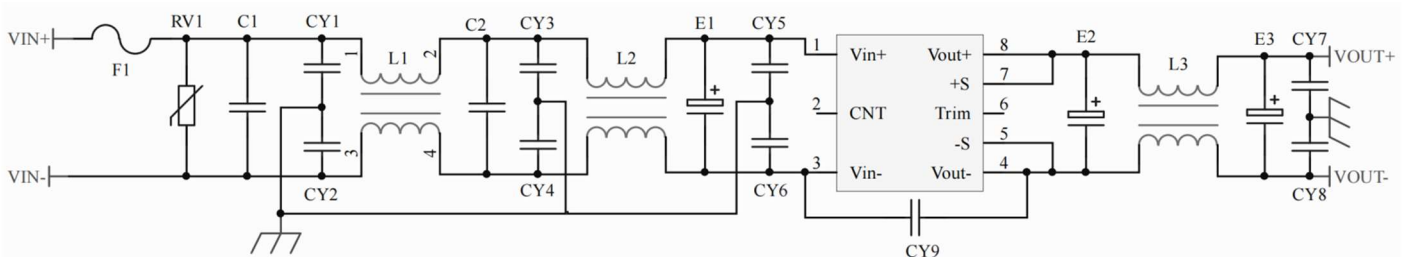

F1	T15A/63V Time-delay fuse
RV1	14D 63V Varistor
C1, C2	105/63V Polyester Film Capacitor
CY1, CY2, CY3, CY4, CY5, CY6	102/250Vac Y2 capacitor
CY7, CY8	103/2KV Ceramic Capacitor
CY9	471/250Vac Y2 capacitor
E1	220μF/50V Electrolytic Capacitor
E2, E3	220μF/35V Electrolytic Capacitor
L1,L2	>3mH, temperature rise less than 25°@14A
L3	>0.5mH, temperature rise less than 25°K@7A

3. Remote control (CNT) application

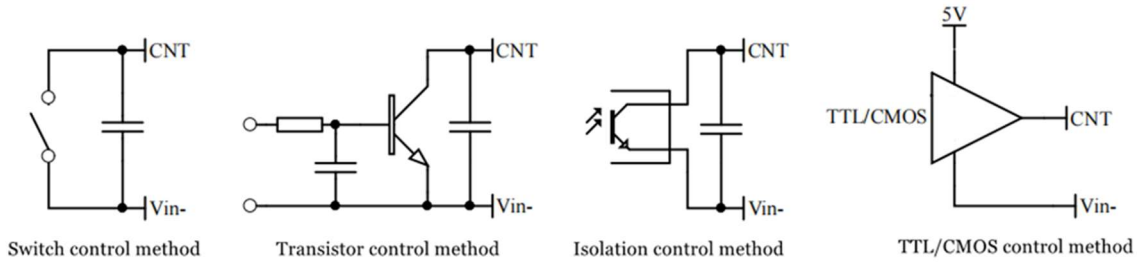

4. Application for Sense

1) With NO distal end compensation

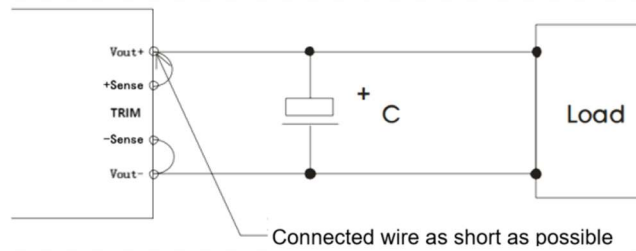

- Notes:
1. Vout+ & Sense+, Vout- & Sense- should be shorted when distal compensation is not needed
 2. The lead wire between Vout+ and Sense+, Vout- and Sense- should be as short as possible, and close to the pins, or else the output may be unstable.

2) With distal end compensation

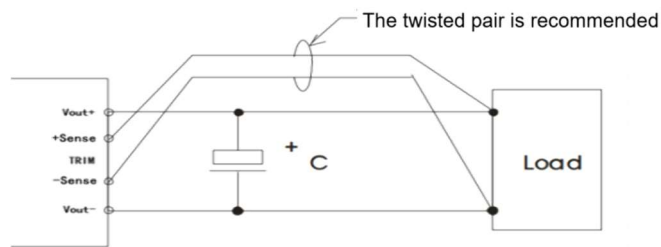

- Notes:
1. The output voltage may be unstable if the compensation cables are too long.
 2. The Twisted pair or shielded cables are recommended, the cable length should be as short as possible.
 3. Wide copper path on PCB or thick lead wires between the power supply and the load should be used to achieve the line voltage drop <0.3V. The target is to keep output voltage within the specified range.
 4. The leads wire resistance may create the output voltage oscillation or larger ripples. Please verify it before to use.

5. TRIM & TRIM resistance calculation

The calculation of ΔU and Rup & Rdown:

$$R_{up} = 70 / \Delta U - 5.1 (K\Omega)$$

$$R_{down} = 28 * (24 - 2.5 - \Delta U) / \Delta U - 5.1 (K\Omega)$$

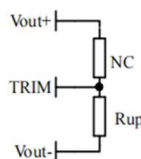

Voltage-up: Add Rup between Trim and Vout-

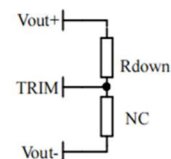

Voltage-down: Add Rdown between Trim and Vout+

6. This converter is not available for connection in parallel to increase the output power. Please contact Aipu technician for this kind of requirement.

Others

1. The product warranty period is two years. The failed product can be repaired/replaced free of charge if it operates at normal condition. A paid service shall be also provided if the product failed after operating under wrong or unreasonable conditions.
2. Aipupower can provide customization design and filter modules for matching, please contact our technician for details.

Guangzhou Aipu Electron Technology Co., Ltd

Address: Building 4, HEDY Park, No.63, Punan Road, Huangpu Dist, Guangzhou, China.

Tel: 86-20-84206763 Fax: 86-20-84206762 HOTLINE: 400-889-8821

E-mail: sales@aipu-elec.com Website: www.aipupower.com